

le GUIDE di ATLANTIS

ATLANTIS
FITTING EMOTIONS

Shopper

semplicemente utili
simply useful

Vuoi una shopper?
Do you need a shopper?



ATLANTISBAGS

Scopri il nostro mondo delle shopper.

Discover our shopping bag world.

*è la risposta
is the answer*

**polyester
eco
small
recycle
large
woven**

•••

**what u
need?**



Oggi c'è più scelta nel mondo delle shopper, uno dei migliori mezzi di comunicazione per ampliare il vostro business. Con il nostro servizio esclusivo siamo in grado di proporvi varie tipologie di shopper da personalizzare, a seconda delle vostre esigenze di immagine, di tempo e budget, fornendovi un prodotto che soddisferà le vostre aspettative.

Perché non provarci?

Now there's more choice in the world of shopping bags, one of the best communication vehicles for your business. We can offer you an opportunity to customize any type of shopper, depending on your time, budget and image requirements, giving you a product that will always meet your expectations.

Why don't try?



NON WOVEN



NON WOVEN MATT LAMINATION



NON WOVEN MATT LAMINATION



NON WOVEN MATT LAMINATION



WOVEN SHINY LAMINATION



WOVEN SHINY LAMINATION



WOVEN SHINY LAMINATION



POLYESTER



POLYESTER

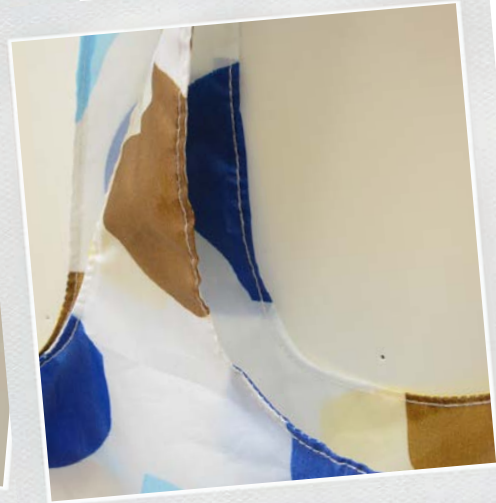

POLYESTER

I prodotti presenti in questo catalogo sono stati realizzati da Master Italia S.p.A. per conto dei Committenti i quali rimangono esclusivi proprietari e/o utilizzatori dei relativi marchi, brevetti, modelli e disegni. Master Italia S.p.A. rimane quindi esonerata da ogni responsabilità in relazione ai beni oggetto di proprietà industriale dei Committenti, non commercializzando alcuno di essi. Gli stessi sono stati qui inseriti al solo scopo di evidenziare l'elevata qualità dei prodotti e della produzione di Master Italia S.p.A.

The products in this catalog are manufactured by Master Italy SpA on behalf of Clients which are exclusive owners and / or users of related marks, patents, utility models and designs. Master S.p.A. Italy is then released from all liability in respect of goods the subject of industrial property of the Customers, not marketing any of them. They have been included here just to highlight the high quality of products and production of Master Italy S.p.A.

Una linea di shoppers adatte ad ogni scopo, per l'uso quotidiano, per i regali aziendali, per i negozi, per il tempo libero.

Dedicata ai materiali naturali, ecologici, riciclabili. Perché il mondo ha bisogno di nuova energia.

A shoppers line suitable for every purpose, for everyday use, corporate gifts, shops and leisure.

Made of natural materials, environment friendly, recyclable. The world needs a new energy.



PP NON WOVEN BAG

Tessuto Non Tessuto (TNT) è il termine generico per indicare un prodotto industriale simile a un tessuto ma ottenuto con procedimenti diversi dalla tessitura. Le principali caratteristiche sono: idrorepellenza, resistenza a temperature elevate, non abrasività al tatto. Nell'uso quotidiano trova applicazione in oggetti quali ad esempio sacchetti, borse piccole e grandi per la spesa, per contenere giornali, materiale vario. Può essere personalizzato con stampa serigrafica a più colori.

Nonwoven is the generic term for an industrial product like a fabric but obtained by different procedure than weaving. The main features are: water resistance, resistance to high temperatures, not abrasive to the touch. In daily use finds application in objects such as bags, small and big shopper, to contain newspapers or various material. The Nonwoven fabric can be customized with silk printing in various colors.



PP NON WOVEN + LAMINATION BAG

Il Tessuto Non Tessuto può essere personalizzato con stampe in quadricromia accoppiando alla base un film (foglio molto sottile ma resistente) che può essere lucido o opaco, che viene stampato in precedenza con macchine offset. L'applicazione di questo foglio rende più resistente la shopper che quindi sopporta pesi maggiori nel trasporto.

Nonwoven fabric can be customized with 4 color process print by joining it with a transparent film (very thin but strong), with matt or glossy finishing, previously printed with offset machines. The application of this sheet makes the shopper more resistant.



PP WOVEN + LAMINATION BAG

Prodotto ottenuto dalla tessitura, mediante fibre incrociate, che vengono unite per realizzare una shopper molto resistente, grazie anche al fatto che viene accoppiato un foglio, stampato in precedenza con macchine offset, che potrà avere finitura lucida o opaca.

Synthetic fabric obtained by weaving fibers, joined together to achieve a very resistant shopper, thanks also to the fact that the fabric is coupled with a film previously printed with offset machines, that can have shiny or gloss finishing.



POLYESTER BAG

Come la maggior parte delle fibre sintetiche, il Poliestere rispetto alle fibre naturali presenta importanti vantaggi: maggiore resistenza all'usura, non viene attaccato dalle tarme, è leggero, se bagnato si asciuga in fretta. Inoltre è molto resistente e facilmente stampabile.

The Polyester, as most of the synthetic fibers, has quite a lot of advantages if compared with natural ones: high resistance to wear, cannot be attacked by moths, lightweight, dries quickly when wet. It is also very durable and easy to be printed.





PP NON WOVEN

tnt (tessuto non tessuto)
non woven fabric



consegna
delivery

12 settimane *weeks*



quantità
minima
m.o.q.

3.000 pezzi *pcs.*



peso
tessuto
*fabric
weight*

da 70 a 100 g/m²
from 70 to 100 g/m²



carico per
il trasporto
max weight

ideale per carichi
leggeri e medi
*suitable for light
and medium weight*



personalizzazione
customization

stampa tradizionale max 3 colori
max 3 colours print



Atlantis shopper®
NON WOVEN WITH 1 COLOUR PRINT
80 GSM
NON WOVEN HANDLES 40x3 cm.
SIZE 35x35x20 cm.



formati
suggeriti
*suggested
size*

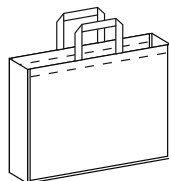

55x48x14
short/long handle
+/- 140 g/m²

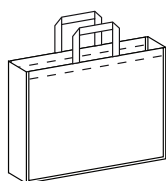

45x35x12
short/long handle
+/- 120 g/m²

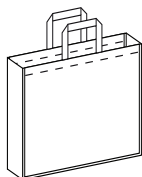

38x38x10
short/long handle
+/- 100 g/m²

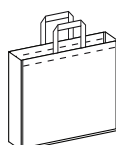

35x35x8
short/long handle
+/- 80 g/m²



handles reinforcement
(optional)

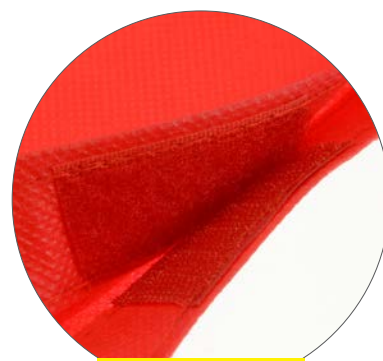

velcro closure

PP NON WOVEN + LAMINATION

tnt (tessuto non tessuto) con laminazione lucida/opaca/metallizzata
non woven fabric with shiny, matt or metallic lamination



consegna
delivery

12 settimane *weeks*



quantità
minima
m.o.q.

3.000 pezzi *pcs.*



peso
tessuto
*fabric
weight*

da 100 a 160 g/m²
from 100 to 160 g/m²



carico per
il trasporto
max weight

ideale per carichi
medi e pesanti
*suitable for medium
and heavy weight*



personalizzazione
customization

stampa in quadricromia
4 colours process print (cmyk)



Atlantis shopper®
NON WOVEN WITH MATT LAMINATION
4 COLOURS PROCESS PRINT ON ALL SIDES
120 GSM
WEBBING HANDLES 40x4 cm.
SIZE 30x30x20 cm.



formati
suggeriti
*suggested
size*

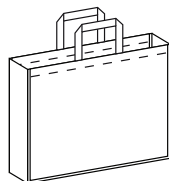

50x40x18
short/long handle
+/- 140 g/m²

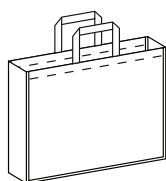

44x40x20
short/long handle
+/- 130 g/m²

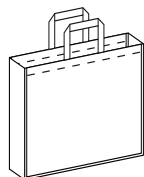

42x35x24
short/long handle
+/- 120 g/m²

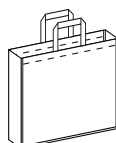

38x38x10
short/long handle
+/- 110 g/m²



webbing handles

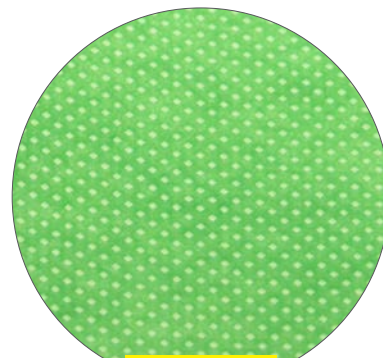

inside view

PP WOVEN + LAMINATION

fibra intrecciata laminazione lucida/opaca
woven fabric with shiny or matt lamination



consegna
delivery

12 settimane *weeks*



quantità
minima
m.o.q.

3.000 pezzi *pcs.*



peso
tessuto
fabric
weight

da 120 a 140 g/m²
from 120 to 140 g/m²



carico per
il trasporto
max weight

ideale per carichi
pesanti
*suitable for heavy
weight*



personalizzazione
customization

stampa in quadricromia
4 colours process print (cmyk)

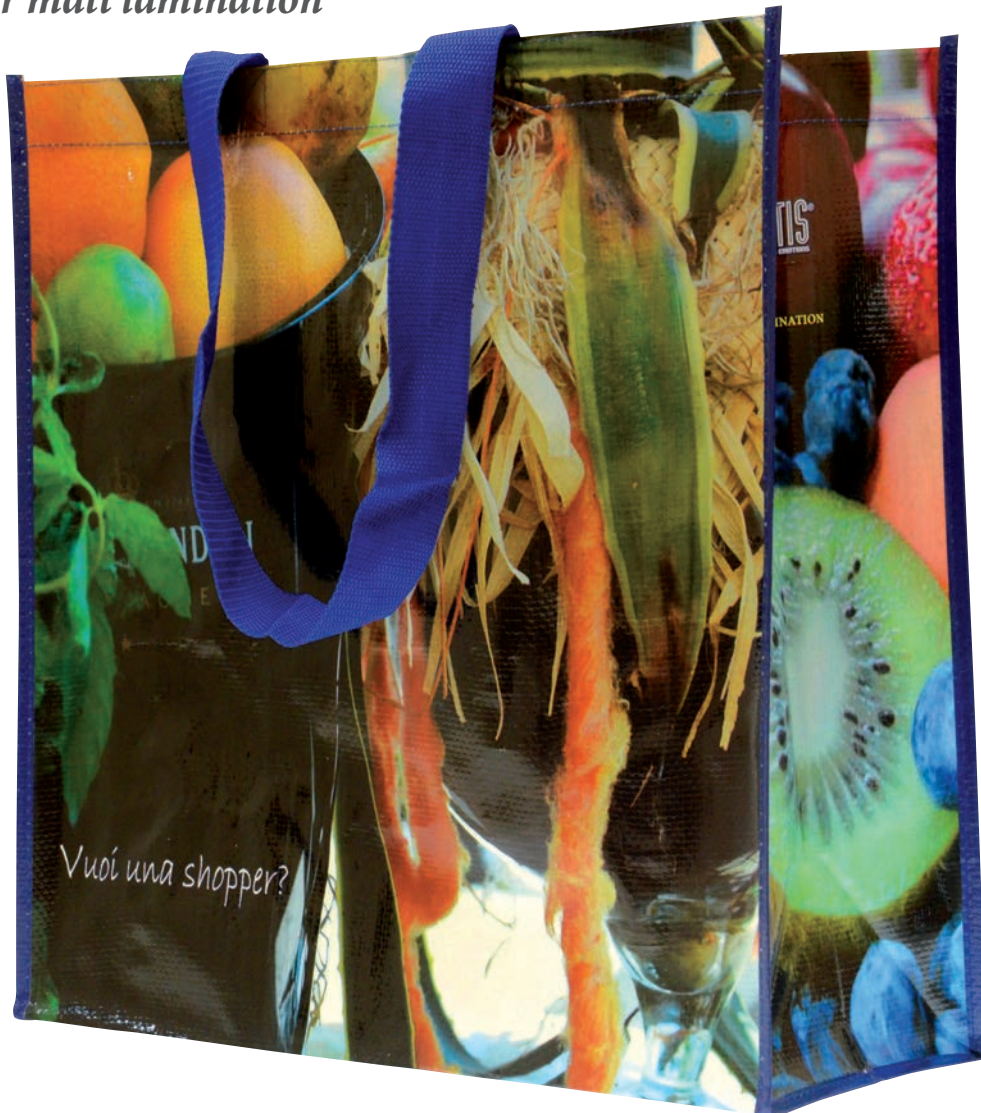

Atlantis shopper®
PP WOVEN WITH SHINY LAMINATION
4 COLOURS PROCESS PRINT ON ALL SIDES
140 GSM
WEBBING HANDLES 60x4 cm.
SIZE 44x40x20 cm.



formati
suggeriti
*suggested
size*

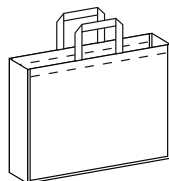

50x40x18
short/long handle
+/- 140 g/m²

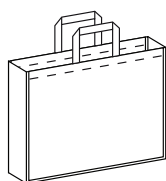

44x40x20
short/long handle
+/- 130 g/m²

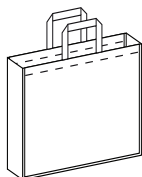

42x35x24
short/long handle
+/- 120 g/m²

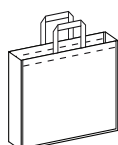

38x38x10
short/long handle
+/- 110 g/m²

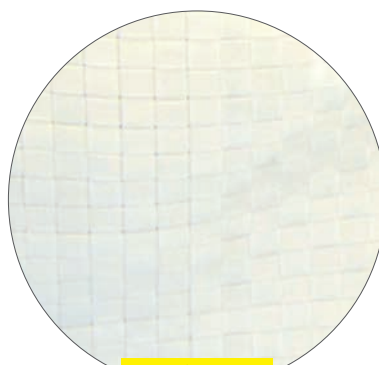

inside view

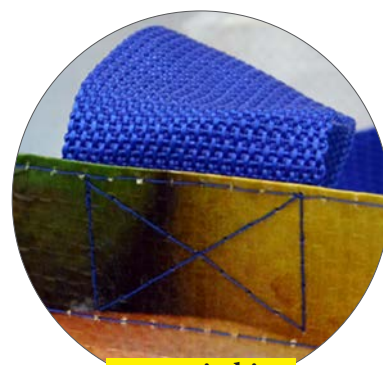

cross stitching

POLYESTER

fibra sintetica
synthetic fiber



consegna
delivery

12 settimane *weeks*



quantità
minima
m.o.q.

5.000 pezzi *pcs.*



tessuto
*fabric
details*

190T - 210D



carico per
il trasporto
max weight

ideale per carichi
leggeri e medi
*suitable for light
and medium weight*



personalizzazione
customization

stampa tradizionale o quadricromia
standard or 4 colours process print (cmyk)



formati
suggeriti
*suggested
size*

formati su richiesta
size on demand



Polyester foldable shopper
SIZE 40x69 cm.



folded



velcro

QUOTATION REQUEST

COMPANY NAME.....

REF. PERSON.....

BAG FABRIC: NON WOVEN

NON WOVEN WITH LAMINATION

WOVEN WITH LAMINATION

POLYESTER

FABRIC WEIGHT: 70gr/m2

80gr/m2

90gr/m2

other...

ORDER Q.TY

(min. 3000 pcs)

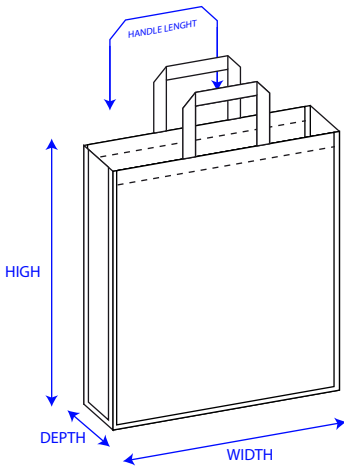

BAG SIZE (CM) width

height

depth

HANDLE SIZE (CM) width

length

HANDLE FABRIC SELF FABRIC

WEBBING

- ✘ all gusset
- + bottom
- side gusset

OPTIONAL ACCESSORIES

- Velcro closure
- Snap button closure
- Lamination inside
- Wineyard collection
- Plastic bottom reinforced

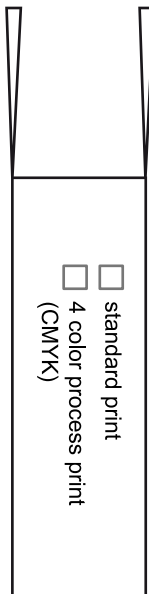

LEFT SIDE

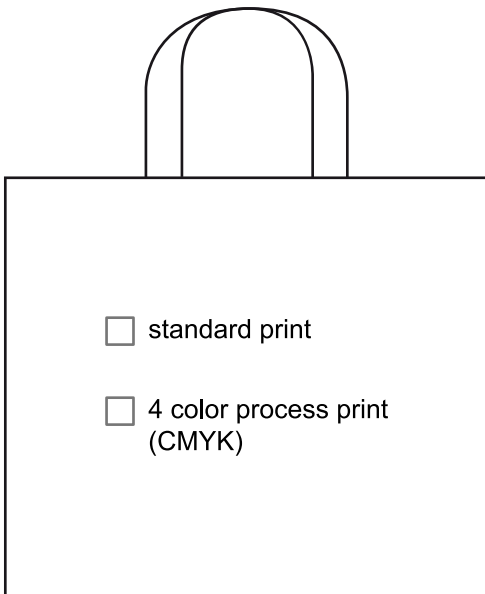

FRONT SIDE

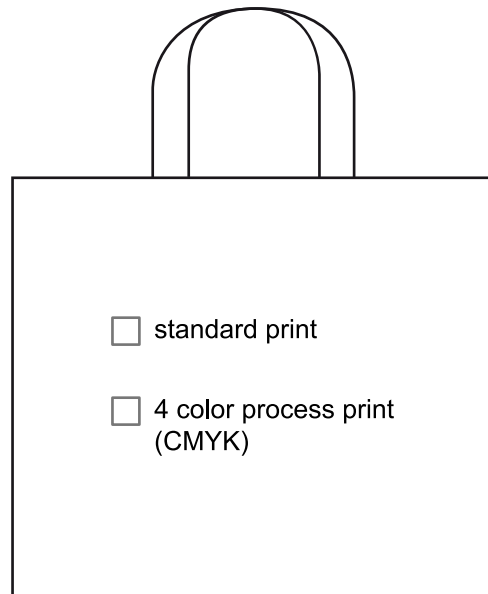

BACK SIDE

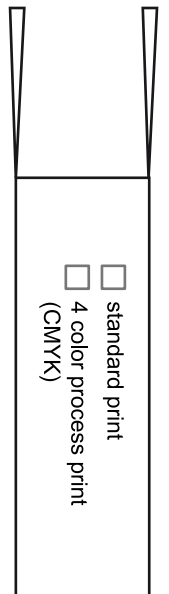

RIGHT SIDE

****THE IMAGE OR LOGO MUST BE IN VECTORIAL FORMAT****



PP NON WOVEN



PTF6443



PTF6781



PTF6213



PTF1443

PP NON WOVEN LAMINATION



PTF9665 (matt)



PTF9876 (shiny)



PTF9324 (shiny)



PTF9123 (shiny)

PP WOVEN LAMINATION



PTF8796 (matt)



PTF8843 (shiny)

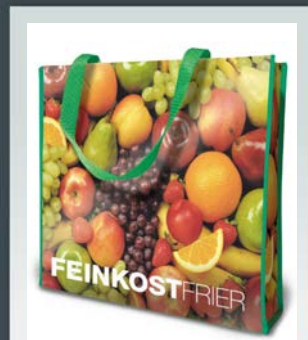

PTF8772 (shiny)



PTF8882 (shiny)

POLYESTER



PTF7723



PTF7654



PTF7776

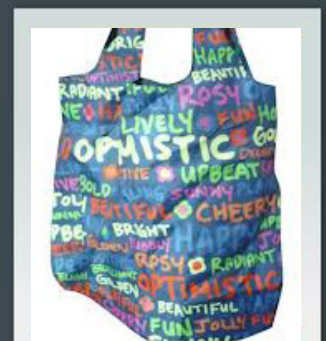

PTF7591

